

Best Manufacturer & Supplier of **PLASTIC PALLETS** in India

Awarded By - Worldwide Achievers

U n i q u e S o l u t i o n s F o r e v e r

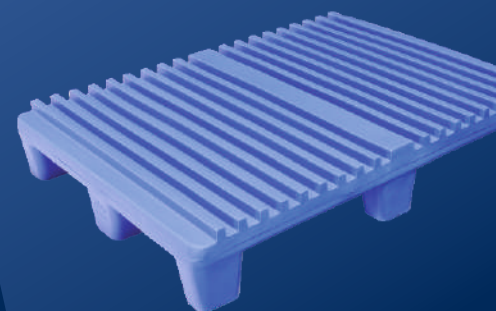
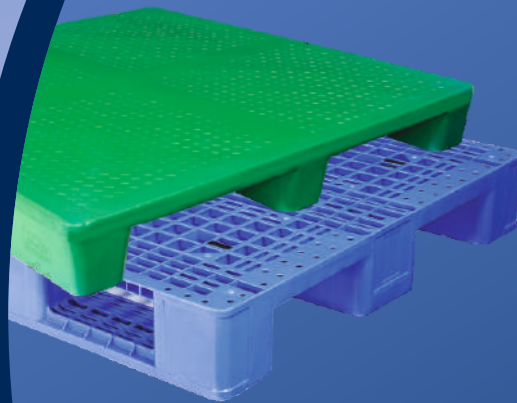
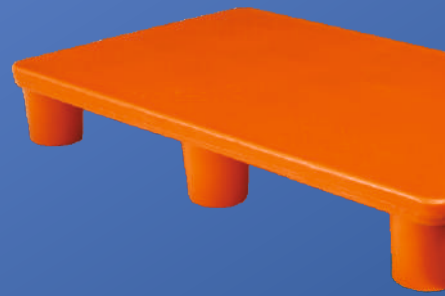

SWIFT Group is a unique thinking and technologically advanced industrial plastic products manufacturer in India and recognized as a leading supplier in industrial plastic products. We offer expertise in plastic molding through our core strength of ability to innovate, design and manufacture wide range of products which is suitable for all kind of industrial segments. We create value for our clients and partners in business. At the same time, our measures ensure we fulfill the diverse needs of customers. We view this as long term of competitive advantage by providing superior products for wider applications from both quality & economic viewpoints. We are committed towards supply good quality products, excelling laid down standards to delight our customers by continually upgrading our skill by maintaining a speedy and flexible approach we have been able to provide a stable and reliable supply base for our customer.

CORE VALUES

▪ **Customer Centric**

We believe that customer is center of our business universe, they actually drives company success and helps in overall development of organization. Hence we will strive to do what is in the best interest of our customer.

▪ **Respect and Care**

We value difference in everyone, hence we respect and treat every human with dignity, courtesy and care.

▪ **Learning**

We believe constant learning is most important aspect to achieve success, excellence and future alignment of the personal & organization growth.

▪ **Adaptability**

In Today dynamic and fast paced global economy we always focus on envisioning future of our organization by anticipating demands so that we can consciously navigate our company for next generation.

▪ **Dedication**

We believe that dedication, commitment, perseverance with integrity & honesty are the key factors to achieve desired objective from any work we do.

R & D - KNOW HOW FOR YOUR ADVANTAGE

Our research and development team work continuously to improve our products. We always try to manufacture products from new advanced raw materials, utilizing the most modern technologies and has a customer centric approach in order to provide for almost every need of customers. Our Modern technology has been mutual benefit for our customer as well as for us. This has also guaranteed high quality performance products for customer specified solutions

We follow a high quality standards of technical excellence scaling new heights in its determination to deliver the best.



SUPERIOR QUALITY STANDARD

Quality is our hallmark, our range of products are in compliance to international quality standards. We always ensure in providing paramount quality products to our esteemed clients. To ensure cost-efficiency & perfect designing, we follow internationally accepted quality parameters. We are committed to supply good quality products, excelling laid down standards to delight our customers.

INNOVATIVE DESIGN & IDEAS

SWIFT works closely with its customers to identify their needs. An effective material handling pallet program begins with a careful analysis of the application. Our team experts provide continuous support to incorporate innovation and cost effective solution.

FLEXIBILITY OF CUSTOMIZATION

SWIFT has the capability to custom design products to meet your specific plastic product's needs. Our ranges of plastic pallets are well suited for all industries. We can design a custom application or provide a proven product that helps to get your material moving in the right direction.

WIDE RANGE OF PRODUCTS

SWIFT is having a 125+ unique variants of pallets which designed as per upfront needs of industries as every company requirement is different by their products, packing or even culture of handling. Apart from that , range of products includes Material handling Equipment, Road Safety Products, Nirmalya Kumbh kalash, Drum Spill Pallets, Custom Design Products and many other plastic products.

AVAILABILITY

We stock plastic pallets for immediate delivery throughout the India, although we can supply a wide range of plastic pallets and as per customer needs.

BENEFITS OF PLASTIC PALLETS

■ Safe for Handling

It is known that faulty wooden pallets are dangerous for the operation. Our pallets will ensure the safety of its usage for a long time and will increase safe material handling on shop floor hence no injuries or material damages.



■ Strong & Durable

One Piece Molding structure of plastic pallets, ensure the safety of its usage for a long time, Even after a few years of usage, our pallets will retain its original condition in terms of size, rigidity and shock absorbency.



Greater automation requires repeatability and reliability, and plastics' tailored designs and consistent dimensions and weights offer a distinct advantage over wood pallets, which are vulnerable to splintering off shards and pulling apart as nails loosen.

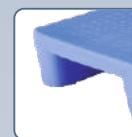

■ Clean & Sanitary

Swift pallets are weather proof, termite proof & Fungus resistant, & can be easily cleaned by water or air.



■ Resistant to Chemicals

Swift plastic pallets are resistant to most chemical hence does not rot, decay, decompose or react with stored material, it will protect your material at their best condition.



■ No Maintenance Cost

One Piece Molded Swift Plastic pallets doesn't require any kind of maintenance No joints, No screw, nails hence No maintenance required like wooden pallet.



■ Standard Design & Specification

Design and specifications of pallet are as per international quality standards; hence swift pallets are suitable for all kind of industries and can be handled by any standard handling equipment.



■ Natural Resources Savings/ Recyclable

Plastic pallets are made from recyclable Polyethylene material. This preserves natural resources, while reducing waste. Wooden pallets consume precious natural resources; up to 10 million trees are cut every year to produce the same.



■ Color choice to customer

We can manufacture pallets as per customer's color choice and it can be color coordinated to identify goods in a warehouse.

Cost effective

The initial cost of plastic pallets is a great deal more than wooden pallets, but Life span of plastic pallets is several times longer than that of the wooden pallets. Due to its durability and benefits, users can realize the cost savings in using plastic pallet within 3 years

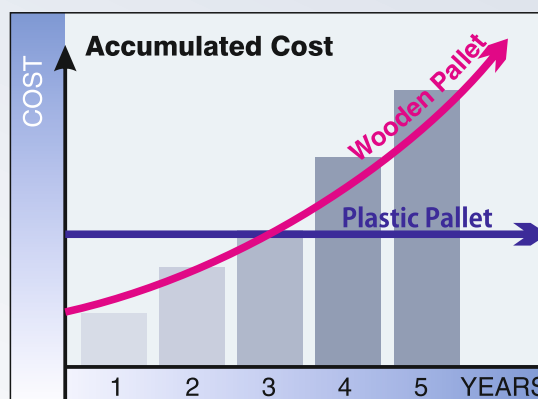

MOLDED PLASTIC PALLETS

Swift Rotomolded plastic pallets are innovative and perfect solution for all kind of industries, specifically these pallets have great benefits for food and pharmaceutical Industries. These are in compliance with GMP/ HACCP/FDA norms of cleanliness and withstand temperatures to -40°C to, 60°C. One Piece molding structure with reinforcement ensures very long life of pallets with many great benefits. Swift pallets are available in many different models, shape, size and colors. A range of Plastic Pallets provides greater choice to our customers & meet their requirements of every storage & material handling application. Swift rotomolded pallets are segregated in different series, which will help our customer to choose their best suit immediately.

- **One Piece Molding**
Rotomolded pallets are molded in one piece body structure with steel reinforcement. No joints, nails hence increase safety on the shop floor, very long life and retain its original shape even after years of usage
- **Smooth Fork Entry**
Swift pallets are designed ergonomically for easy and safe handling. Smooth round leg designs of pallets helps fork to enter in proper way without damaging pallets while handling.
- **Flat Antiskid Top /Flat Plain Top**
Swift plastic Pallets are available with options of Plain top and Antiskid top, Grooved Top, or Custom Shaped Top.
- **High load bearing capacity**
Pallets are made up from best quality polyethylene material with steel reinforcement technology, swift pallets can be supplied for extra heavy application as per customer's needs.
- **TOP Safety Edge**
Plain Top pallets are available with options of top Side Edge, for additional safety while material handling. This feature can be useful for heighten rack storage of light weight products.
- **Rack Guide**
Pallets are available with additional safety features with rack guide, for critical racking application these feature is useful for heighted rack storage of very light weight products.
- **Antistatic Pallets**
An antistatic plastic pallet is reducing static electricity charges on equipment, either to prevent fires and explosions when working with flammable liquids and gases, or to prevent damage to static-sensitive objects such as electronic components or devices.

RANGE OF PLASTIC PALLETS

We are having range of models shapes and size of plastic pallets for every application, every load, it provides greater choice to our customers & meets their requirements of every storage & material handling application. For Heavy, Medium and light weight application.



H - SERIES PLASTIC PALLETS

2 Way Entry Heavy Duty Non Reversible Pallets

H SERIES

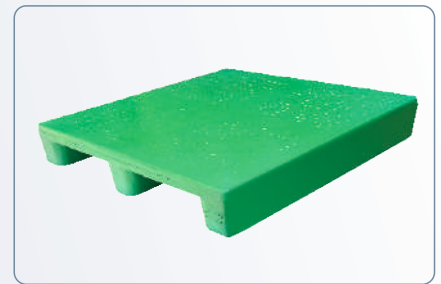
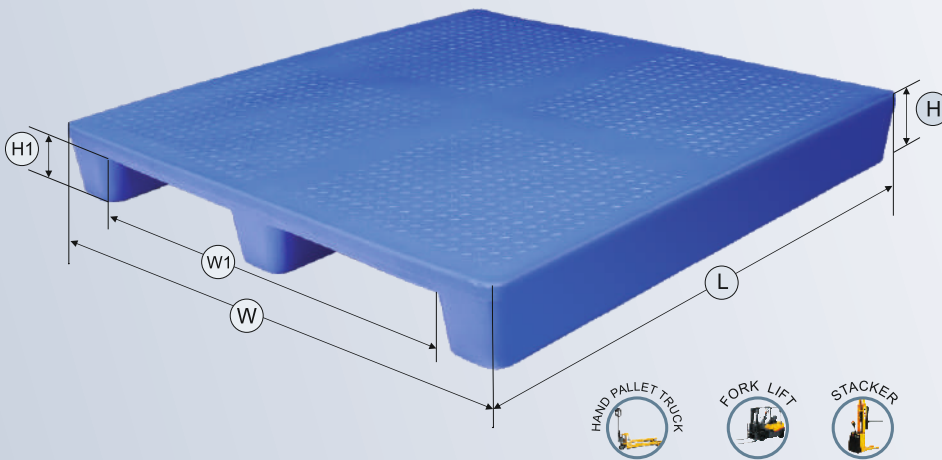

Pallet Specifications

Pallet Type	2 Way Entry Non Reversible
Leg Type	3 longitudinal legs
Horizontal Racking	Suitable
Pallet Top	Plain / Antiskid / Customised*
Colour	Blue/Grey/ Green/White/Black or Any*

Sr. No	Model Number	Pallet Size			Fork entry Side	Fork entry (W1)	Bottom Clearance (H1)	Load Capacity (kg) Up to		
		Length (L)	Width (W)	Height (H)				Static Load	Dynamic Load	Rack Load
1	SIP-H2-1213	1200	1300	150	1300	1020	105	6000	1500	1500
2	SIP-H2-1212	1200	1200	150	1200	920	105	6000	1500	1500
3	SIP-H2-1210	1200	1000	150	1000	760	105	6000	1500	1500
4	SIP-H2-1111	1100	1100	150	1100	840	105	6000	1500	1500
5	SIP-H2-1208	1200	800	150	800	610	105	6000	1500	1500
6	SIP-H2-1012	1000	1200	150	1200	920	105	6000	1500	1500
7	SIP-H2-1010	1000	1000	150	1000	730	105	6000	1500	1500
8	SIP-H2-1008	1000	800	150	800	610	105	6000	1500	1500
9	SIP-H2-0909	900	900	150	900	700	105	6000	1500	1500
10	SIP-H2-0808	800	800	150	800	610	105	6000	1500	1500

Note: Above models can be manufactured with different load bearing capacity as per requirement.



H - SERIES PLASTIC PALLETS

4 Way Entry Heavy Duty Non Reversible Pallets

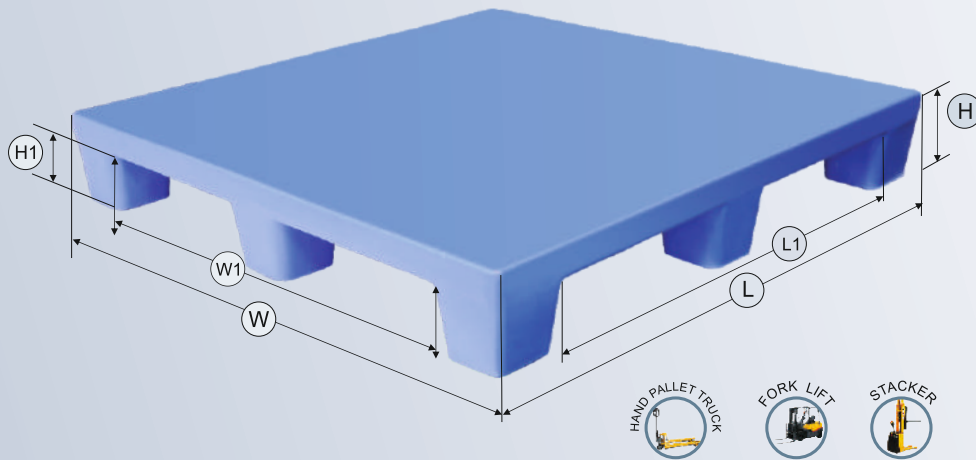

H SERIES

Pallet Specifications

Pallet Type	4 Way Entry Non Reversible
Leg Type	9 legs
Horizontal Racking	Not Suitable
Pallet Top	Plain / Antiskid / Customised*
Colour	Blue/Grey/ Green/White/Black or Any*

Sr. No	Model Number	Pallet Size			Fork entry (L1)	Fork entry (W1)	Bottom Clearance (H1)	Load Capacity (kg) Up to		
		Length (L)	Width (W)	Height (H)				Static Load	Dynamic Load	Rack Load
1	SIP-H4-1212	1200	1200	150	870	870	105	6000	1000	-
2	SIP-H4-1210	1200	1000	150	930	730	105	6000	1000	-
3	SIP-H4-1111	1100	1100	150	840	840	105	6000	1000	-
4	SIP-H4-1208	1200	800	150	920	610	105	6000	1000	-
5	SIP-H4-1206	1200	600	150	910	360	105	6000	1000	-
6	SIP-H4-1010	1000	1000	150	750	750	105	6000	1000	-
7	SIP-H4-1008	1000	800	150	730	610	105	6000	1000	-
8	SIP-H4-0909	900	900	150	660	660	105	6000	1000	-
9	SIP-H4-0808	800	800	150	610	610	105	6000	1000	-
10	SIP-H4-1675	1060	750	150	810	580	105	6000	1000	-
11	SIP-H4-7961	790	610	150	610	430	105	6000	1000	-
12	SIP-H24-1210	1200	1000	150	750	900	115	6000	1000	-

Note: Above models can be manufactured with different load bearing capacity as per requirement.



P - SERIES PLASTIC PALLETS

Warehouse Storage Non Reversible Pallets

P SERIES

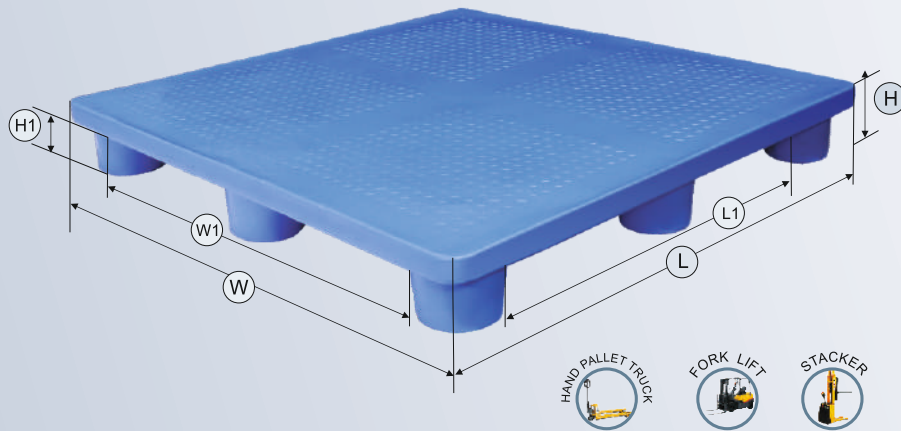

Pallet Specifications

Pallet Type	4 Way Entry Non Reversible
Leg Type	9 legs
Horizontal Racking	Not Suitable
Pallet Top	Plain / Antiskid / Customised*
Colour	Blue/Grey/ Green/White/Black or Any*

Sr. No	Model Number	Pallet Size			Fork entry (L1)	Fork entry (W1)	Bottom Clearance (H1)	Load Capacity (kg) Up to		
		Length (L)	Width (W)	Height (H)				Static Load	Dynamic Load	Rack Load
1	SIP-P4-1008	1000	800	150	730	610	105	4000	750	-
2	SIP-P4-1006	1000	640	150	760	400	105	4000	750	-
3	SIP-P4-9156	915	565	150	715	365	105	4000	750	-
4	SIP-P4-0805	800	580	150	630	410	105	4000	750	-
5	SIP-P2-1210	1200	1000	150	-	760	105	4000	1000	1000

Note: Above models can be manufactured with different load bearing capacity as per requirement.

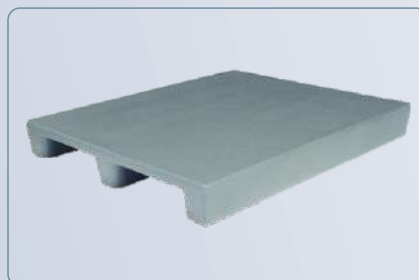

R - SERIES PLASTIC PALLETS

2 Way Entry Non Reversible Plastic Pallets

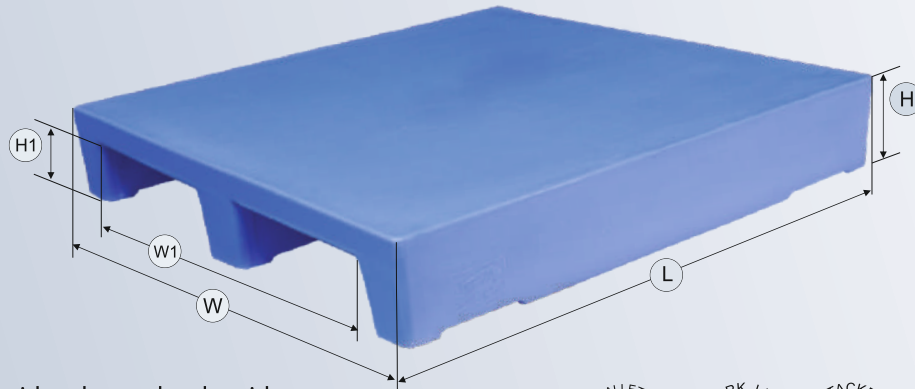

Top side edge and rack guide options available

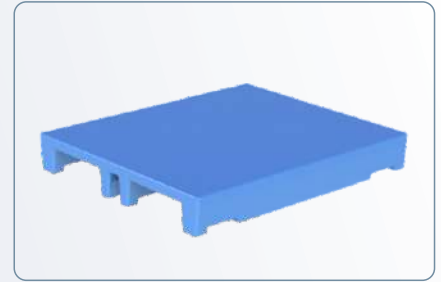

R SERIES

Pallet Specifications

Pallet Type	2 Way Entry Non Reversible
Leg Type	3 longitudinal legs
Horizontal Racking	Suitable
Pallet Top	Plain / Antiskid / with Side Edge
Colour	Blue/Grey/ Green/White/Black or Any*

Sr. No	Model Number	Pallet Size			Fork entry side	Fork entry (W1)	Bottom Clearance (H1)	Load Capacity (kg) Up to		
		Length (L)	Width (W)	Height (H)				Static Load	Dynamic Load	Rack Load
1	SIP-R2-1616	1600	1600	160	1600	1350	115	4000	1000	1000
2	SIP-R2-1515	1500	1500	160	1500	1240	115	4000	1000	1000
3	SIP-R2-1313	1300	1300	165	1300	1040	120	4000	1000	1000
4	SIP-R2-1214	1200	1400	160	1400	1100	110	4000	1000	1000
5	SIP-R2-1312	1350	1225	160	1225	925	110	4000	1000	1000
6	SIP-R2-1212	1200	1200	160	1200	900	110	4000	1000	1000
7	SIP-R2-1210	1200	1000	160	1000	800	115	4000	1000	1000
8	SIP-R2-1216	1220	1016	160	1016	756	115	4000	1000	1000
9	SIP-R2-1111	1100	1100	150	1100	840	105	4000	1000	1000
10	SIP-R2-1208	1200	800	150	800	610	105	4000	1000	1000
11	SIP-R2-1209	1200	900	150	900	700	105	4000	1000	1000
12	SIP-R2-1010	1000	1000	160	1000	750	115	4000	1000	1000
13	SIP-R2-1008	1000	800	150	800	610	105	4000	1000	1000
14	SIP-R2-0909	900	900	150	900	700	105	4000	1000	1000
15	SIP-R2-0808	800	800	160	800	610	115	4000	1000	1000
16	SIP-R2-0812	800	1200	160	1200	900	110	4000	1000	1000
17	SIP-R2-1011TH	1040	1140	145	1140	880	100	4000	1000	1000
18	SIP-R2-1212 (E)	1200	1200	160	1200	1040	110	2000	500	500
19	SIP-R2-1210 (E)	1200	1000	160	1000	780	115	2000	500	500

Note: Above models can be manufactured with different load bearing capacity as per requirement. Sizes may differ by 5 - 10mm.

R - SERIES PLASTIC PALLETS

4 Way Entry Non Reversible Plastic Pallets

R SERIES

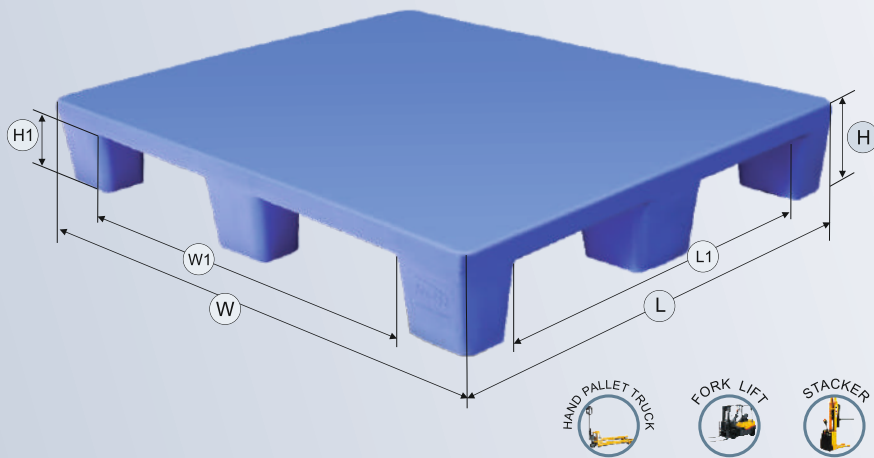

Pallet Specifications

Pallet Type	4 Way Entry Non Reversible
Leg Type	9 legs
Horizontal Racking	Not Suitable
Pallet Top	Plain / Antiskid / Customised*
Colour	Blue/Grey/ Green/White/Black or Any*

Sr. No	Model Number	Pallet Size			Fork entry (L1)	Fork entry (W1)	Bottom Clearance (H1)	Load Capacity (kg) Up to		
		Length (L)	Width (W)	Height (H)				Static Load	Dynamic Load	Rack Load
1	SIP-R4-1515	1500	1500	160	1100	1100	110	4000	1000	-
2	SIP-R4-1212	1200	1200	150	900	900	100	4000	1000	-
3	SIP-R4-1210	1200	1000	160	910	710	100	4000	1000	-
4	SIP-R4-1111	1100	1100	150	820	820	105	4000	1000	-
5	SIP-R4-1208	1200	800	150	930	610	105	4000	1000	-
6	SIP-R4-1010	1000	1000	150	760	760	105	4000	1000	-
7	SIP-R4-1007	1000	700	165	640	590	105	4000	1000	-
8	SIP-R4-0907	900	700	160	640	500	110	4000	1000	-
9	SIP-R4-8363	830	630	175	590	490	100	4000	1000	-
10	SIP-R4-1410	1400	1000	175	1105	805	105	4000	1000	-
11	SIP-R4-1212 (E)	1200	1200	150	880	880	100	2000	500	-
12	SIP-R4-1210 (E)	1200	1000	150	900	700	100	2000	500	-
13	SIP-R4-1010 (E)	1000	1000	140	720	720	105	2000	500	-

Note: Above models can be manufactured with different load bearing capacity as per requirement.



R24 - SERIES PLASTIC PALLETS

4 Way Entry 3 Runner Rackable Plastic Pallets

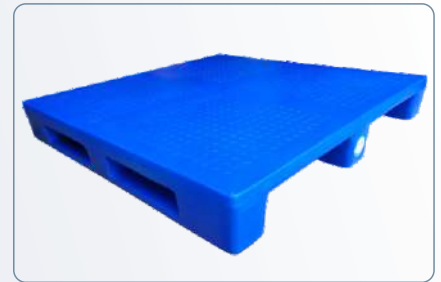
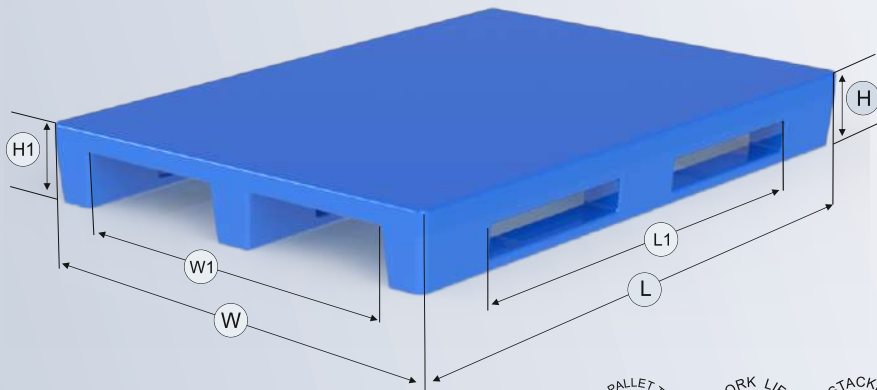

R SERIES

Pallet Specifications

Pallet Type	2 & 4 Way Entry Non-Reversible Pallets
Leg Type	3 Longitudinal Legs with Side Entry
Horizontal Racking	Suitable
Pallet Top	Plain / Antiskid / Grooved
Colour	Blue / Grey / Green / White / Black or Any*

Sr. No	Model Number	Pallet Size			Fork entry (L1)	Fork entry (W1)	Bottom Clearance (H1)	Load Capacity (kg) Up to		
		Length (L)	Width (W)	Height (H)				Static Load	Dynamic Load	Rack Load
1	SIP-H24-1210	1200	1000	165	900	750	120	4000	1000	1000
2	SIP-R24-1212(200H)	1200	1200	200	960	1000	150	4000	1000	1000
3	SIP-R24-1212(165H)	1200	1200	165	800	940	120	4000	1000	1000
4	SIP-R24-1210	1200	1000	165	900	750	120	4000	1000	1000
5	SIP-R24-1210THA	1200	1040	150	666	810	105	4000	1000	1000
6	SIP-R24-1012	1000	1200	160	700	920	115	4000	1000	1000
7	SIP-R24-1313	1130	1130	160	790	850	110	4000	1000	1000
8	SIP-R24-6687	660	870	165	460	670	120	4000	1000	1000
9	SIP-R24-6810	680	1080	165	470	840	120	4000	1000	1000
10	SIP-R24-8110	810	1090	165	570	850	120	4000	1000	1000
11	SIP-R24-8612	865	1205	165	605	945	120	4000	1000	1000
12	SIP-R24-6391	635	910	165	445	710	120	4000	1000	1000
13	SIP-R24-6995	690	955	165	490	755	120	4000	1000	1000
14	SIP-R24-7282	720	820	180	540	640	113	4000	1000	1000

Note: Above models can be manufactured with different load bearing capacity as per requirement.

A - SERIES PLASTIC PALLETS

2 Way Entry Side Wing Pallets

A SERIES

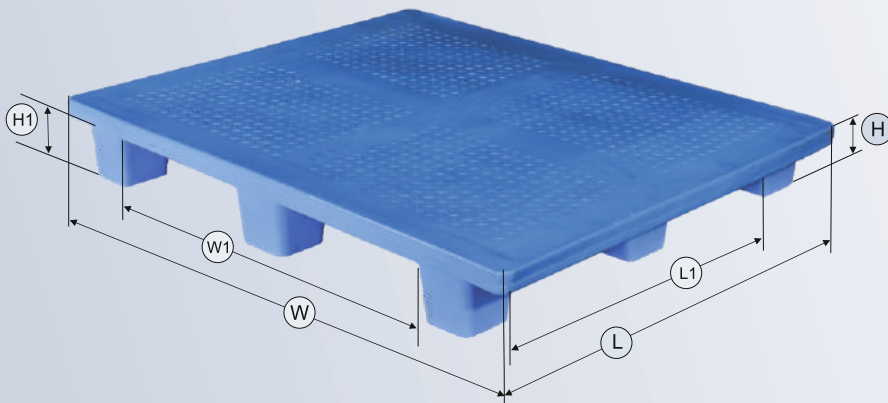

These pallets are specially designed for Edge Racking application in the Drive in Rack Storage.

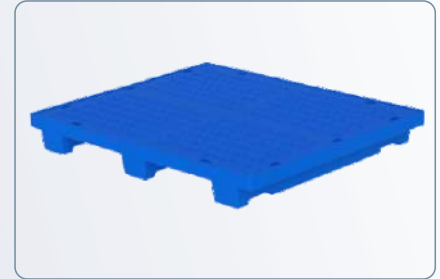

Pallet Specifications

Pallet Type	2 Way Entry Non Reversible
Leg Type	9 legs
Drive-in Racking	Suitable
Pallet Top	Plain / Antiskid / Customised*
Colour	Blue/Grey/Green/White/Black or Any*

Sr. No	Model Number	Pallet Size			Fork entry (L1)	Fork entry (W1)	Bottom Clearance (H1)	Load Capacity (kg) Up to		
		Length (L)	Width (W)	Height (H)				Static Load	Dynamic Load	Rack Load
1	SIP-A4-1212	1200	1200	150	760	960	105	4000	1000	1000
2	SIP-A4-1012	1000	1200	150	732	800	105	4000	1000	1000
3	SIP-A4-1214 <small>Not Suitable for Drive-in Racking</small>	1200	1400	165	-	950	100	4000	1000	1000

Note: Above models can be manufactured with different load bearing capacity as per requirement.



PRINTING PALLETS

4 Way Entry Non Reversible Pallets

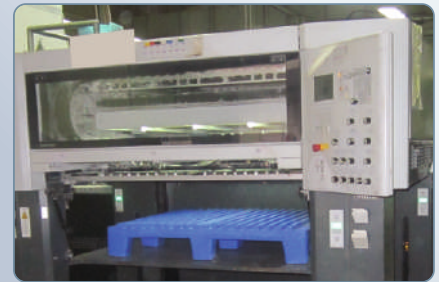
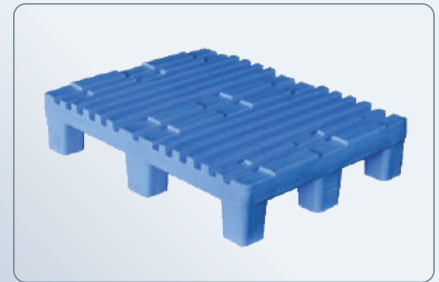
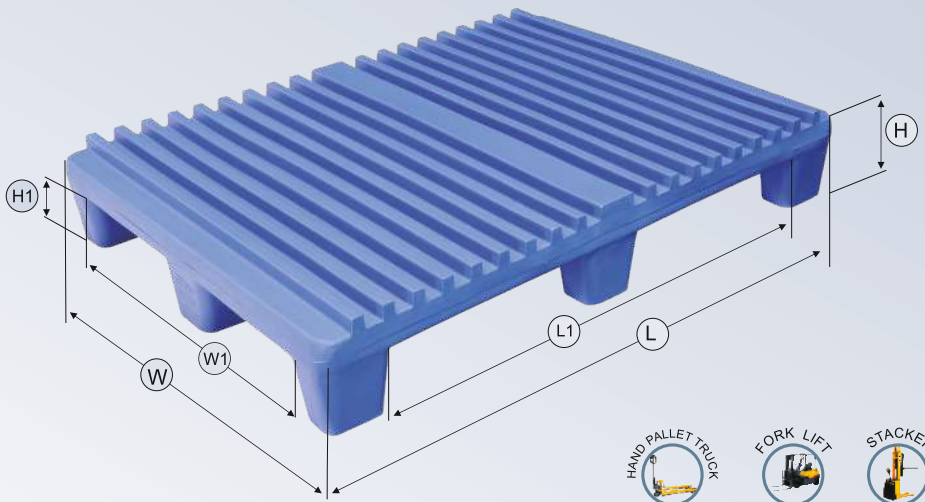

PRINTING PALLETS

Pallet Specifications

Pallet Type	4 Way Entry Non Reversible
Leg Type	9 legs & 3 Longitudinal legs with Side Entry
Horizontal Racking	Suitable
Pallet Top	Plain / Antiskid / Grooved / Roll Guide
Colour	Blue/Grey/ Green/White/Black or Any*

Sr. No	Model Number	Pallet Size			Fork entry (L1)	Fork entry (W1)	Bottom Clearance (H1)	Load Capacity (kg) Up to		
		Length (L)	Width (W)	Height (H)				Static Load	Dynamic Load	Rack Load
1	SIP-H4-1675	1060	750	175	810	570	105	4000	1000	-
2	SIP-H4-7961	790	610	175	610	430	105	4000	1000	-
3	SIP-P4-1006	1000	640	150	760	400	105	4000	1000	-
4	SIP-P4-9156	915	565	150	715	365	105	4000	1000	-
5	SIP-P4-0805	800	580	150	630	410	105	4000	750	-
6	SIP-R4-9865	985	655	165	785	495	105	4000	1000	-
7	SIP-R4-1007	1000	700	165	640	590	100	4000	1000	-
8	SIP-R4-0907	900	700	160	640	500	110	4000	1000	-
9	SIP-R4-1410	1465	1065	175	1005	805	103	4000	1000	-
10	SIP-R24-6687	660	870	165	460	670	120	4000	1000	1000
11	SIP-R24-6810	680	1080	165	470	840	120	4000	1000	1000
12	SIP-R24-8110	810	1090	165	570	850	120	4000	1000	1000
13	SIP-R24-8612	865	1205	165	605	944	120	4000	1000	1000
14	SIP-R24-6391	635	910	165	445	710	120	4000	1000	1000
15	SIP-R24-6995	690	955	165	490	755	120	4000	1000	1000

Note: Above models can be manufactured with different load bearing capacity as per requirement.

Roll Pallets

Heavy Duty Pallets For Roll Application

ROLL PALLETS

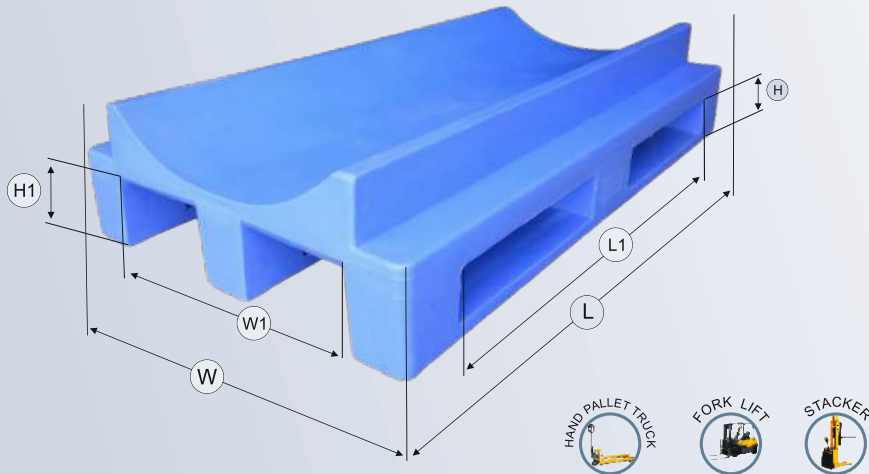

Pallet Specifications

Pallet Type	Non-Reversible Roll Pallets
Leg Type	3 Longitudinal Legs with Roll Guide
Racking	Suitable
Pallet Top	Roll Guide Top
Colour	Blue / Grey / Orange / White / Black or Any*

Sr. No	Model Number	Pallet Size			Fork entry (L1)	Fork entry (W1)	Bottom Clearance (H1)	Load Capacity (kg) Up to		
		Length (L)	Width (W)	Height (H)				Static Load	Dynamic Load	Rack Load
1	SIP-R2-0812RP	800	1200	200	NA	920	105	4000	1000	1000
2	SIP-R2-0912RP	900	1200	230	NA	910	115	4000	1000	1000
3	SIP-R24-1207RP	1200	700	260	960	500	115	4000	1000	1000

Note: Above models can be manufactured with different load bearing capacity as per requirement.



HDPE Injection Molding Plastic Pallets

Heavy Duty Stackable Plastic Pallets

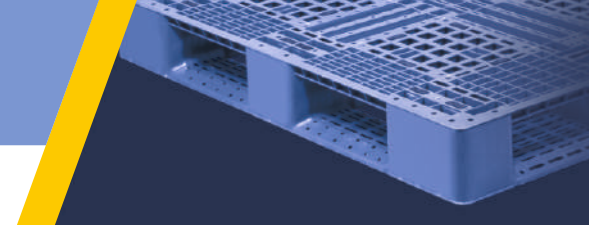

HDPE PALLETS

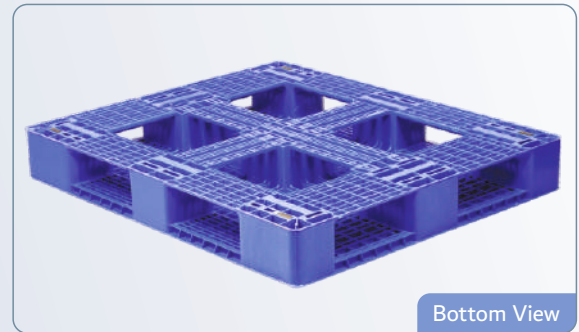
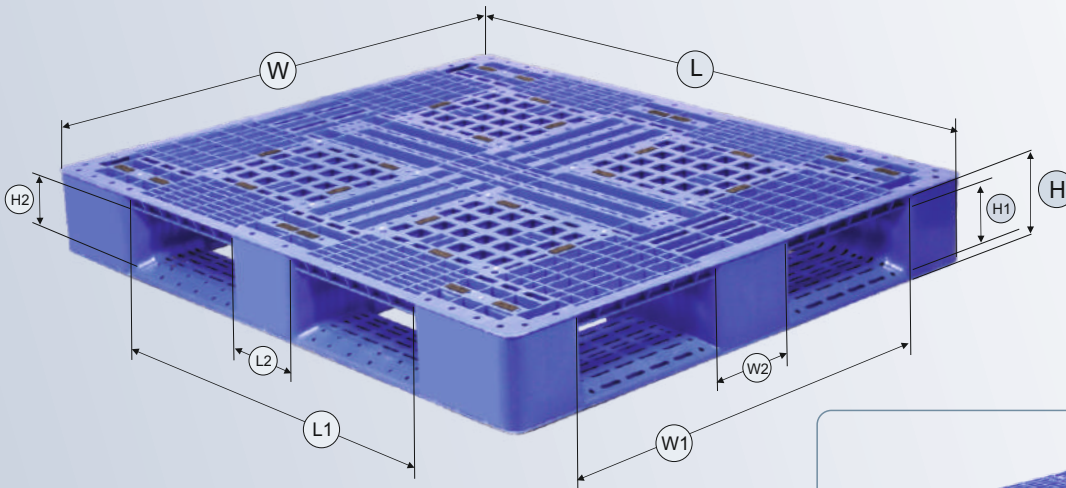

Pallet Specifications

Pallet Type	4 Way Entry Double Deck
Leg Type	Bottom Deck
Racking	Suitable
Pallet Top	Perforated
Colour	Blue/Grey/Green/Black or Any*



Sr. No	Model Number	Pallet Size			Fork entry (L1)	Leg Size (L2)	Fork entry (W1)	Leg Size (W2)	Bottom Fork Clearance (H1)	Bottom Fork Clearance (H2)	Load Suitability		
		Length (L)	Width (W)	Height (H)							Static Load	Dynamic Load	Rack Load
1	SIP-M24-1515DH	1500	1500	155	1100	500	1100	500	96	96	6000	1200	-
2	SIP-M24-1311DH	1300	1100	165	900	150	800	150	95	95	4000	1000	-
3	SIP-M24-1212DH	1200	1200	150	730	190	730	190	90	90	4000	800	-
4	SIP-M24-1210DH	1200	1000	150	730	190	700	190	95	95	4000	800	-

Note: Racking Load is different as per application of user.

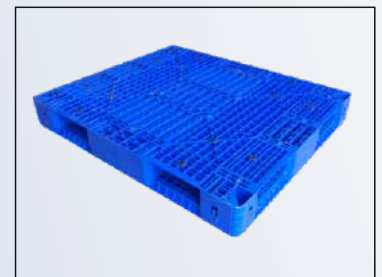
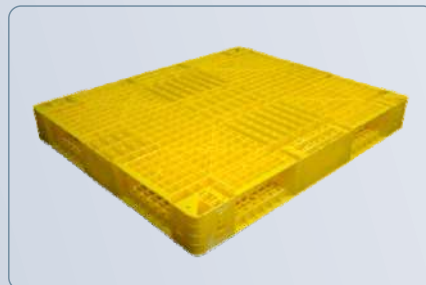

HDPE Injection Molding Plastic Pallets

Multi Purpose, Multi Variants Plastic Pallets



HDPE PALLETS

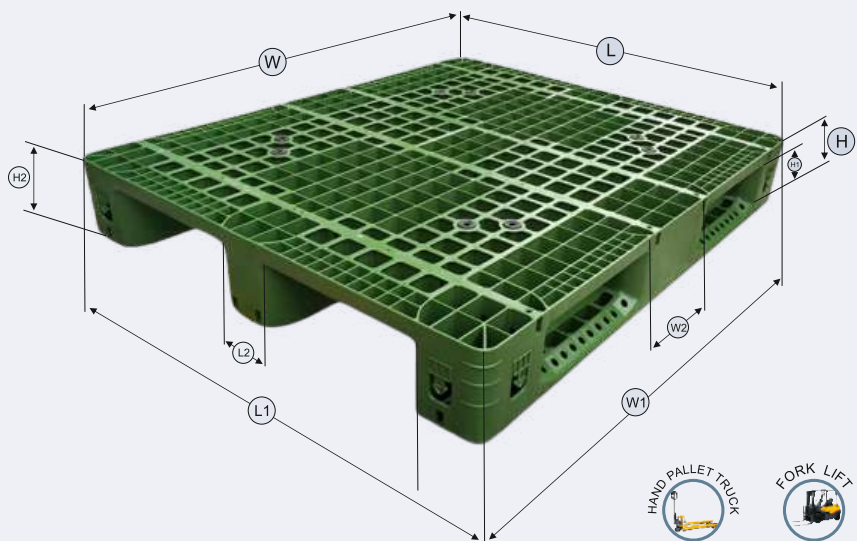

Pallet Specifications

Pallet Type	4 Way Entry Non Reversible
Leg Type	3 longitudinal legs
Racking	Suitable for Horizontal & Drive-in rack
Pallet Top	Perforated / Flat
Colour	Blue/Grey/Green/Black or Any*

Sr. No	Model Number	Pallet Size			Fork entry (L1)	Leg Size (L2)	Fork entry (W1)	Leg Size (W2)	Bottom Fork Clearance (H1)	Bottom Fork Clearance (H2)	Load Suitability		
		Length (L)	Width (W)	Height (H)							Static Load	Dynamic Load	Rack Load
1	SIP-M24-1212NH	1200	1200	160	880	360	860	180	115	70	4000	1000	1000
2	SIP-M24-1210NHH	1200	1000	160	880	360	700	180	115	70	6000	1000	1000
3	SIP-M24-1210NH	1200	1000	160	880	360	700	180	115	70	4000	1000	1000
4	SIP-M24-1111NH	1100	1100	160	800	200	800	200	115	85	4000	1000	1000
5	SIP-M24-1208NH	1200	800	145	710	190	600	190	105	80	4000	750	750
6	SIP-M24-1208NH-WP	1200	800	165	700	195	610	195	195	115	4000	800	800
7	SIP-M24-1208NH-WF	1200	800	165	700	150	610	195	195	115	4000	800	800
8	SIP-M24-1208NHR	1200	800	145	710	190	600	190	110	80	4000	750	1000
9	SIP-M24-1210NHR	1200	1100	160	880	360	700	180	115	70	6000	1000	1500



HDPE Injection Molded Plastic Pallets

Multi Purpose, Multi Variants Plastic Pallets



HDPE PALLETS

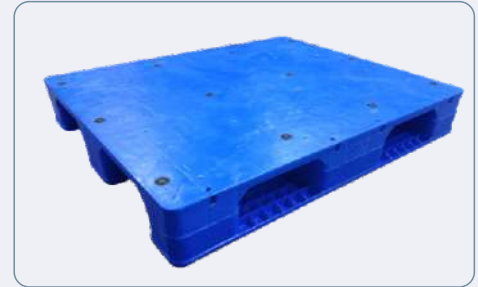
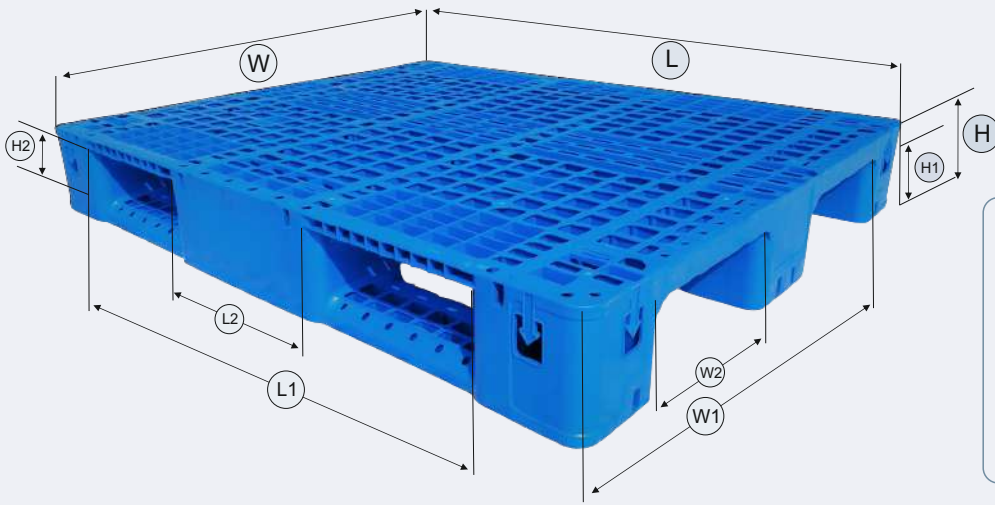

Plain bottom option available

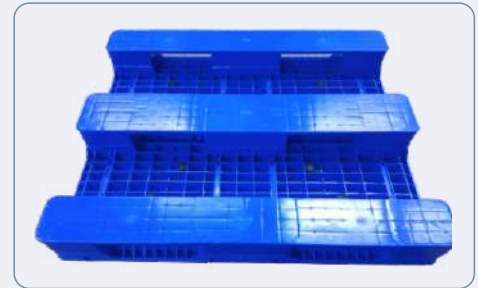

Plain bottom option available for Radio Shuttle Application



Strapping Hooks
2x4=8 Nos Strapping Hook Provision



Steel Tubes
Having 8 Steel Rods Reinforcement Provision (Optional)



Perforated Top
Provide Improved Ventilation and Product Stability



HDPE Injection Molding Plastic Pallets

4 Way Entry Double Deck Medium Duty Pallets



HDPE PALLETS

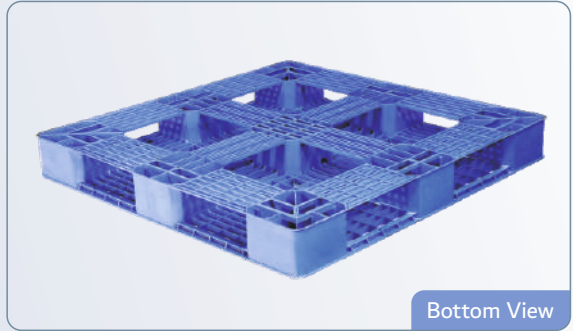
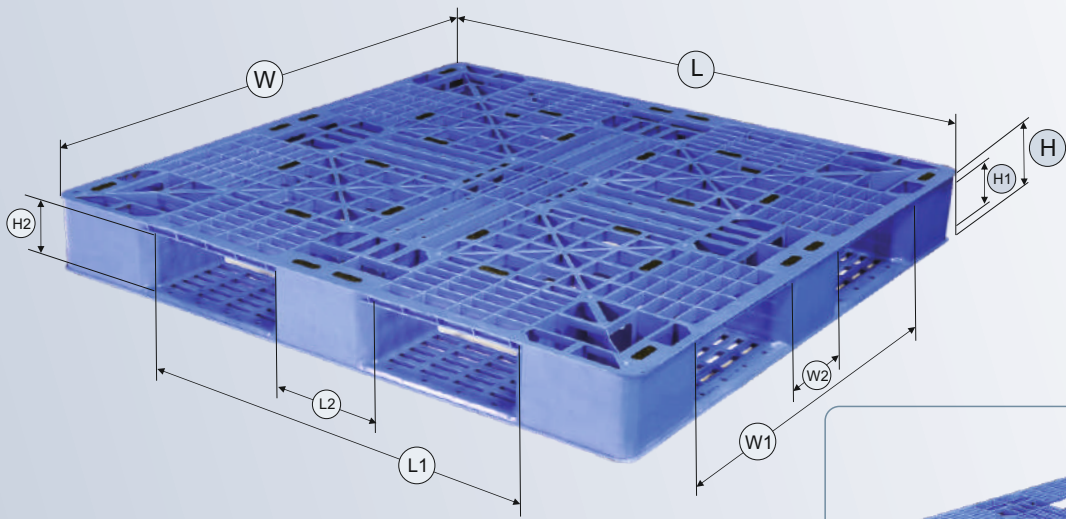

Pallet Specifications

Pallet Type	4 Way Entry Double Deck
Leg Type	Bottom Deck
Racking	Not recommended
Pallet Top	Perforated
Colour	Blue/Grey/Green/Black or Any*



Sr. No	Model Number	Pallet Size			Fork entry (L1)	Leg Size (L2)	Fork entry (W1)	Leg Size (W2)	Bottom Fork Clearance (H1)	Bottom Fork Clearance (H2)	Load Suitability		
		Length (L)	Width (W)	Height (H)							Static Load	Dynamic Load	Rack Load
1	SIP-M24-1111DM	1100	1100	150	730	190	700	190	90	90	4000	750	750
2	SIP-M24-1210DM	1200	1000	120	730	190	700	190	75	75	3000	500	NA
3	SIP-M24-1111DM(L)	1100	1100	120	720	190	720	190	100	100	3000	500	NA
4	SIP-M24-1010DM	1050	1050	125	680	190	680	190	90	90	4000	500	NA

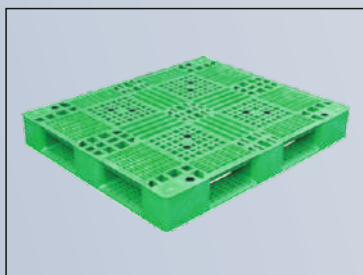

HDPE Injection Molding Plastic Pallets

4 Way Entry Reversible Pallets

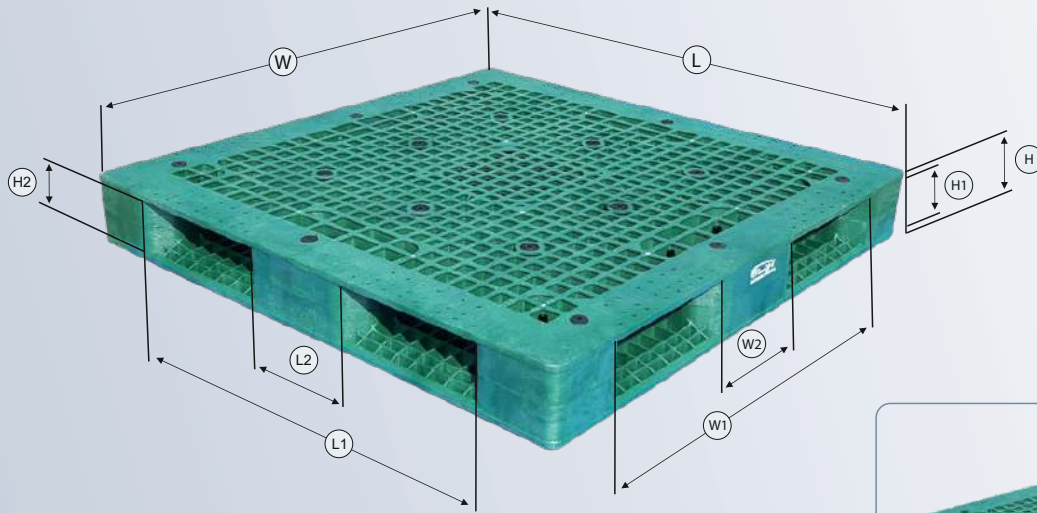

Pallet Specifications

Pallet Type	4 Way Entry Reversible Deck
Leg Type	Bottom Deck
Racking	Suitable for Horizontal & Drive-in rack
Pallet Top	Perforated / Flat
Colour	Blue/Grey/Green/Red/Black



Sr. No	Model Number	Pallet Size			Fork entry (L1)	Leg Size (L2)	Fork entry (W1)	Leg Size (W2)	Bottom Fork Clearance	Load Suitability		
		Length (L)	Width (W)	Height (H)						Static Load	Dynamic Load	Rack Load
1	SIP-M24-1212RH	1200	1200	150	800	310	800	310	80	6000	1000	1000
2	SIP-M24-1311RH	1300	1100	160	800	200	800	200	85	6000	1000	1000
3	SIP-M24-1210RH	1200	1000	160	790	280	720	220	85	6000	1000	1000
4	SIP-M24-1111RH	1100	1100	160	790	280	790	790	85	6000	1000	1000
5	SIP-M24-1515RH	1500	1500	150	1080	480	1080	480	90	6000	1000	1000
5	SIP-M24-1412RH	1400	1200	150	980	480	800	480	85	6000	2000	1500



HDPE PALLETS

HDPE Injection Molding Plastic Pallets

2 & 4 Way Entry Non Reversible-Non Rackable Pallets

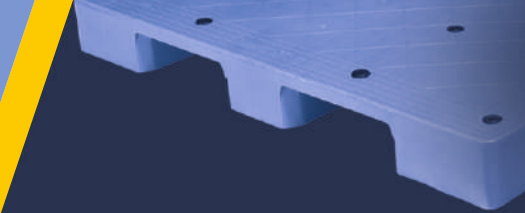

HDPE PALLETS

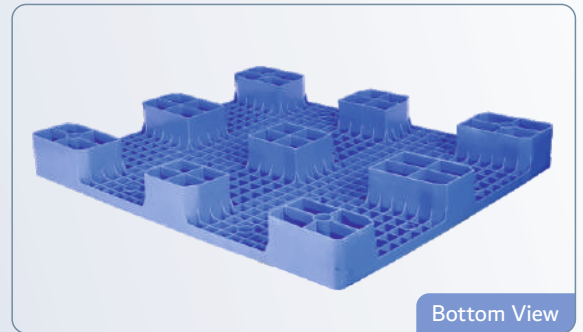
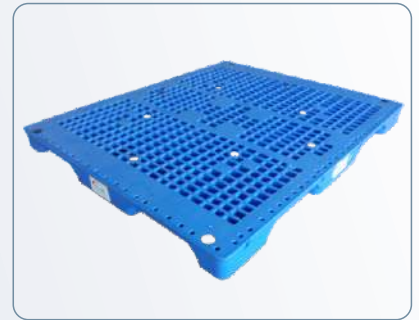
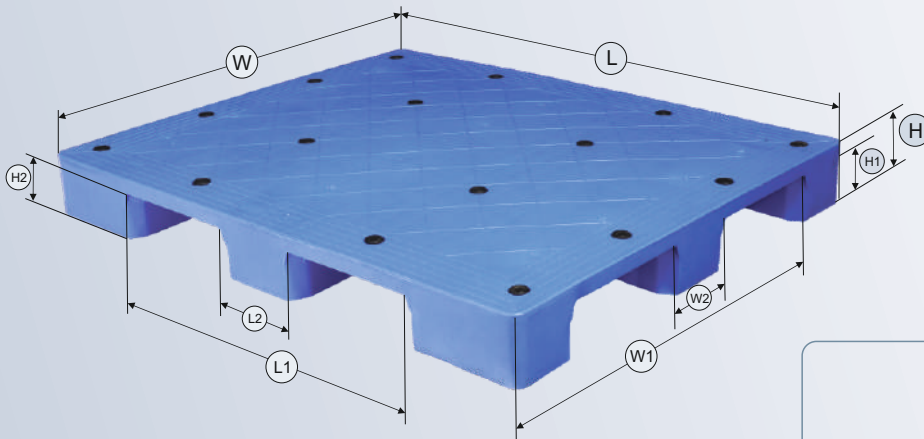

Pallet Specifications

Pallet Type	4 Way Entry Non Reversible
Leg Type	9 legs / 3 Longitudinal legs
Racking	Not Suitable
Pallet Top	Plain / Perforated
Colour	Blue/Green/Black or Any*



Sr. No	Model Number	Pallet Size			Fork entry (L1)	Leg Size (L2)	Fork entry (W1)	Leg Size (W2)	Bottom Fork Clearance (H1)	Bottom Fork Clearance (H2)	Load Suitability		
		Length (L)	Width (W)	Height (H)							Static Load	Dynamic Load	Rack Load
1	SIP-M4-1210NF	1200	1000	125	700	200	665	210	95	95	4000	-	-
2	SIP-M4-1208NF	1200	800	125	710	190	600	190	80	80	4000	500	-
3	SIP-M4-1208NP	1200	800	125	710	190	600	190	80	80	4000	500	-



EXPORT One way Cargo Plastic Pallets

4 Way Entry Double Deck Pallets

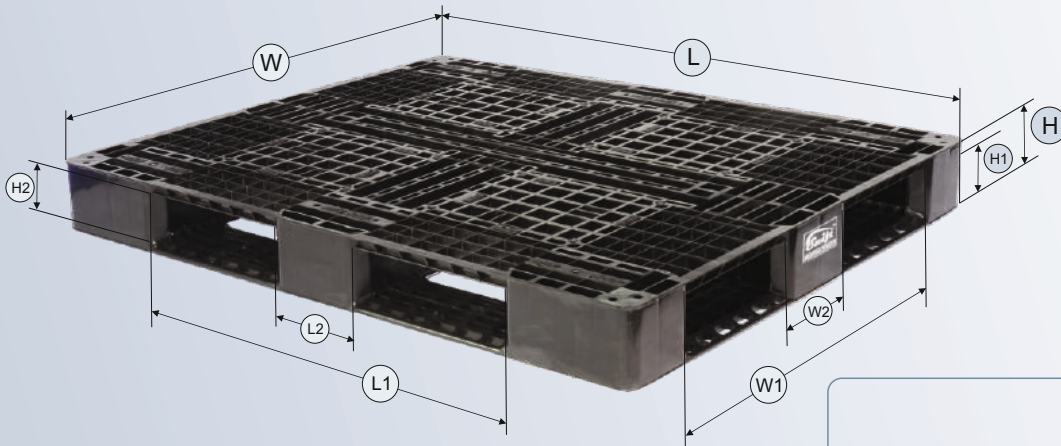

EXPORT PALLETS

Pallet Specifications

Pallet Type	4 Way Entry Double Deck
Leg Type	Bottom Deck
Racking	Not recommended
Pallet Top	Perforated
Colour	Black



Sr. No	Model Number	Pallet Size			Fork entry (L1)	Leg Size (L2)	Fork entry (W1)	Leg Size (W2)	Bottom Fork Clearance (H1)	Bottom Fork Clearance (H2)	Load Suitability		
		Length (L)	Width (W)	Height (H)							Static Load	Dynamic Load	Rack Load
1	SIP-M24-1210DE	1200	1000	120	730	190	700	190	80	80	3000	1000	-
2	SIP-M24-1111DE	1100	1100	150	720	190	720	190	100	100	3000	1000	-
3	SIP-M24-1111DE-L	1100	1100	120	720	190	720	190	80	80	3000	1000	-
4	SIP-M24-1010DE	1050	1050	120	680	195	680	195	90	90	3000	1000	-

Note: Load bearing capacity given in above table are after stretch wrapping & strapping.

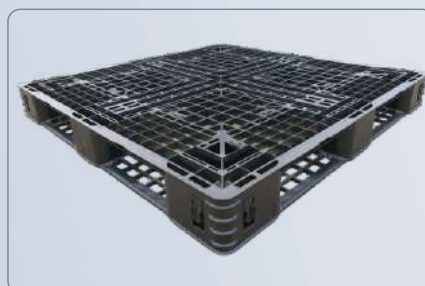

EXPORT One way Cargo Plastic Pallets

4 Way Entry Non Reversible EURO Pallets



EXPORT PALLETS

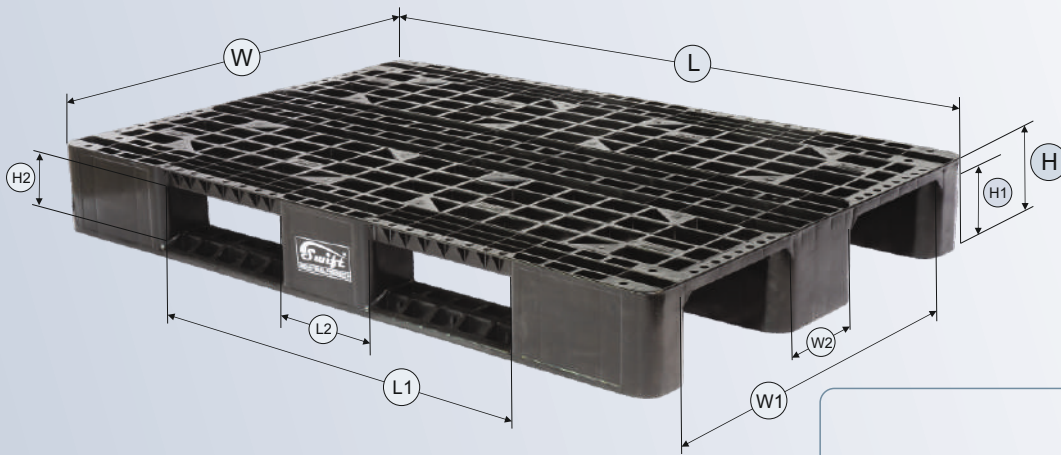

Pallet Specifications

Pallet Type	2 & 4 Way Entry Double Deck
Leg Type	3 longitudinal legs
Racking	Suitable
Pallet Top	Perforated
Colour	Black



Sr. No	Model Number	Pallet Size			Fork entry (L1)	Leg Size (L2)	Fork entry (W1)	Leg Size (W2)	Bottom Fork Clearance (H1)	Bottom Fork Clearance (H2)	Load Suitability		
		Length (L)	Width (W)	Height (H)							Static Load	Dynamic Load	Rack Load
1	SIP-M24-1208NE	1200	800	145	710	190	600	196	110	80	3000	750	750

* Load bearing capacity given in above table are after stretch wrapping & strapping

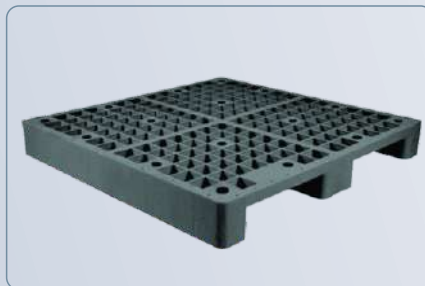

EXPORT One way Cargo Plastic Pallets

4 Way Entry Non Reversible Pallets

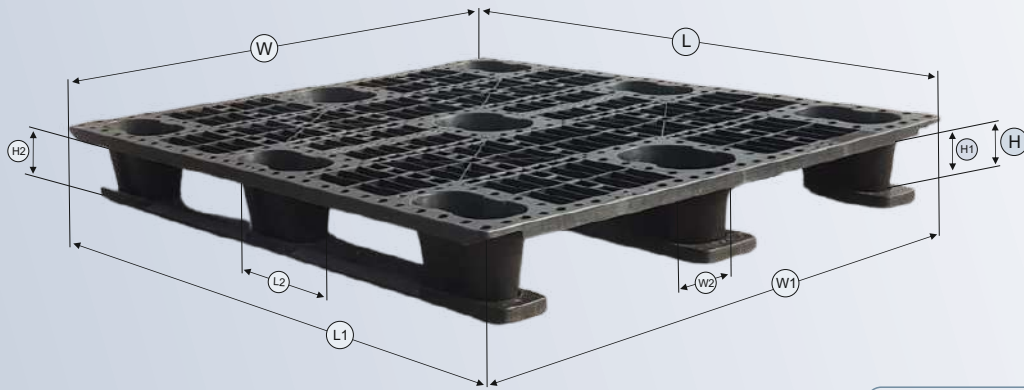

EXPORT PALLETS

Pallet Specifications

Pallet Type	4 Way Entry Non Reversible
Leg Type	9 legs
Racking	Not Suitable
Pallet Top	Perforated
Colour	Black / Blue



Sr. No	Model Number	Pallet Size			Fork entry (L1)	Leg Size (L2)	Fork entry (W1)	Leg Size (W2)	Bottom Fork Clearance (H1)	Bottom Fork Clearance (H2)	Load Suitability		
		Length (L)	Width (W)	Height (H)							Static Load	Dynamic Load	Rack Load
1	SIP-M4-1208NE	1200	800	130	810	150	560	110	105	105	3000	1000	-
2	SIP-M4-1210NE	1200	1000	130	740	200	700	110	105	105	3000	1000	-
3	SIP-M4-1210NE-S	1200	1000	145	740	200	700	110	105	105	3000	1000	-
4	SIP-M4-1208NE-S	1200	800	145	810	150	560	110	105	105	3000	1000	-

* Load bearing capacity given in above table are after stretch wrapping & strapping





PALLET CONTAINER



Model No.	: SIP-H2-1208350PC
Product Size (mm)	: L1200 x W800 H350 mm



Model No.	: SIP-H2-1208550PC
Product Size (mm)	: L1200 x W800 H550 mm



PALLET CONTAINER BOX BIN

OTHER PALLETS

2 WAY ENTRY RACKABLE PLASTIC PALLET with STRAPPING BELT

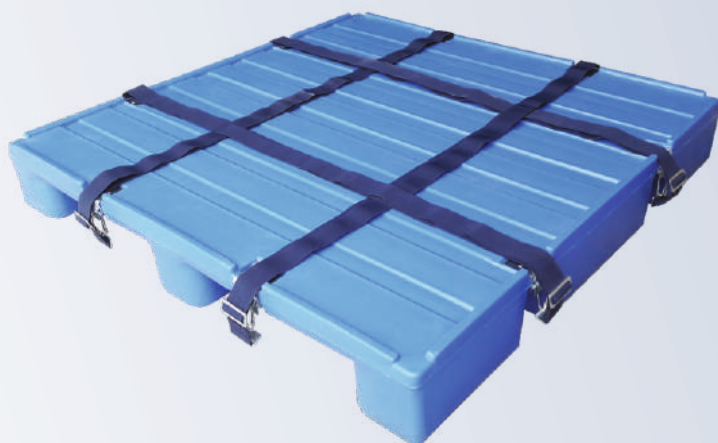

Model No.	: SIP-R2-1212GS-SO
Product Size (mm)	: L1200 x W1200 H160 mm



OTHER PALLETS

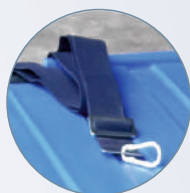

Stretchable rubber strap helps to hold the material with extra stability



Metal clamp increase the life of strapping



Provision for adjustment of strap



Safety edge to avoid slipping of material from pallet

PRECISION ITEM STORAGE TRAY

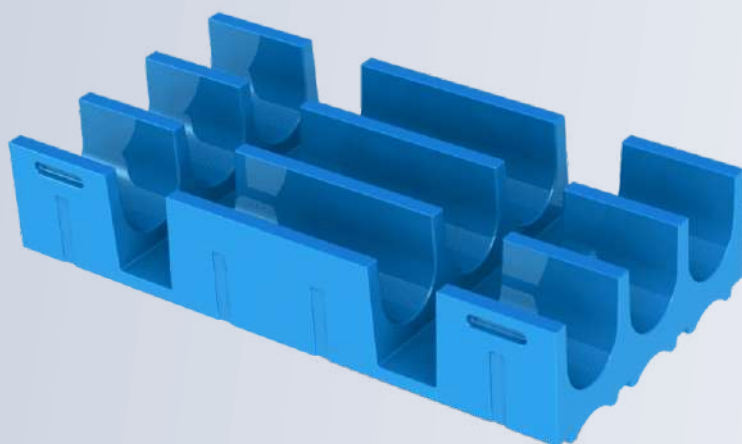

Model No.	: SIP-BTS-1265
Product Size (mm)	: L1270 x W650 H250 mm

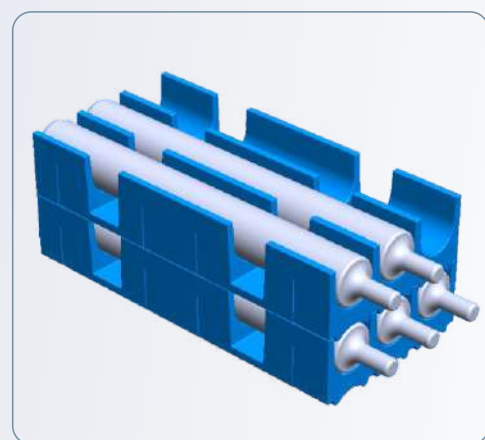

Features:

- Manufactured from high Quality UV Food Grade polyethylene Material.
- Resistant to most of chemicals.
- Comply with GMP / HACCP / FDA / ISPM 15 Norms.
- Compatible with all standard handling equipment's.



DRUM SPILL PLASTIC PRODUCTS

DRUM PALLETS

DRUM SPILL CONTAINMENT PALLET:

Drum spill containment pallets are specially designed for the safe storage of oils, chemicals, catching the any leaks, drips, spills. These pallets are made up from high quality polyethylene materials and reliable construction, ergonomics and safety on the shop floor. Our drum spill containment will change your working environment. Our drum spill pallets are having reliable chemical compatibility and resistance - preventing corrosion and deterioration, assuring a long lifetime of service.

4 Drum Spill Containment Pallets - Double Wall

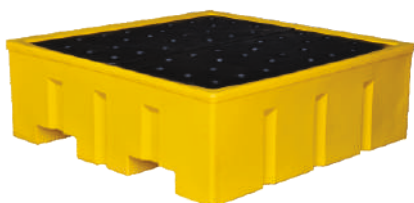

Code	: DSCP-DL4
Description	: 4 Drum Spill Containment Pallets Double Wall
Size	: L1300 x W1300 x H450mm

2 Drum Spill Containment Pallets - Double Wall



Code	: DSCP-DL2
Description	: 2 Drum Spill Containment Pallets Double Wall
Size	: L1390 x W990 x H380mm

4 Drum Spill Containment Pallets



Code	: DSCP-SL4-1227
Description	: 4 Drum Spill Containment Pallets
Size	: L1270 x W1270 x H200mm

4 Drum Spill Containment Pallets

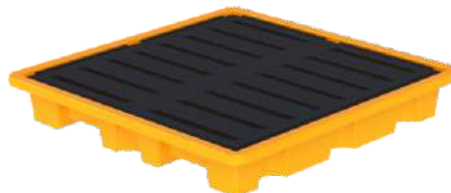

Code	: DSCP-SL4-1313
Description	: 4 Drum Spill Containment Pallets
Size	: L1300 x W1300 x H200mm

4 Drum Spill Containment Pallets



Code	: DSCP-SL4-1212
Description	: 4 Drum Spill Containment Pallets
Size	: L1200 x W1200 x H160mm

2 Drum Spill Containment Pallets



Code	: DSCP-SL2
Description	: 2 Drum Spill Containment Pallets
Size	: L1260 x W660 x H200mm

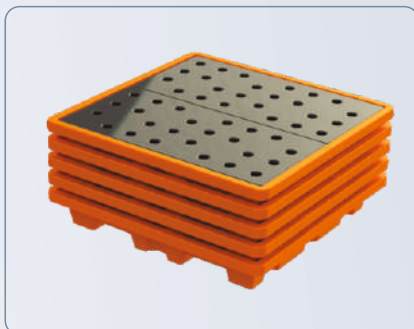



DRUM SPILL PLASTIC PRODUCTS

DRUM PALLETS

Single Drum Spill Containment Pallets - Double Wall



Code	: DSCP-DL1
Description	: 4 Drum Spill Containment Pallets Double Wall
Size	: L800 x W800 x H250mm

Single Drum Spill Containment Pallets



Code	: DSCP-SL1
Description	: Single Drum Spill Containment Pallets
Size	: Dia 820 x H220mm

Laboratory Spill Tray



Code	: IC-3018
Description	: Laboratory Spill Tray - 3018
Size	: L750 x W450 x H40mm

Laboratory Spill Tray



Code	: IC-1818
Description	: Laboratory Spill Tray - 1818
Size	: L450 x W450 x H40mm

IBC Spill Containment Pallet

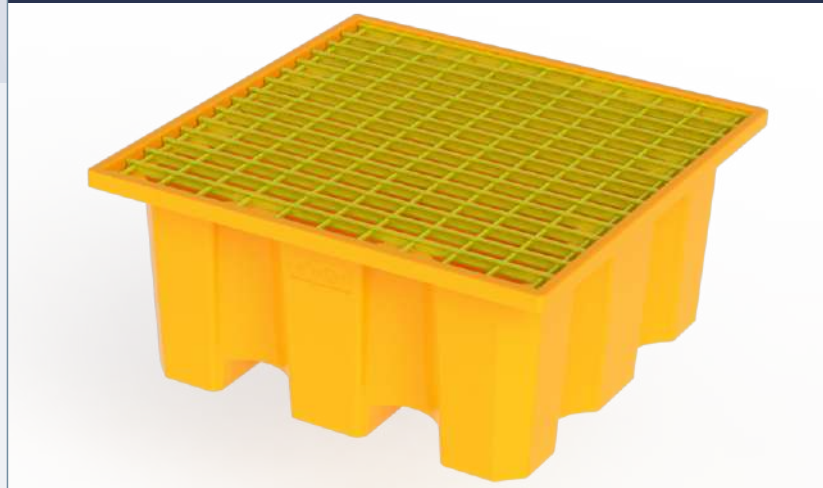

Code	: IBCP-SL4-1313
Description	: IBC Spill Containment Pallets Single Layer



OTHER PRODUCTS



INSULATED ICE BOX

Insulated ice boxes are specially designed containers with built-in insulation to maintain the cold temperature of contents, making them ideal for storing and transporting chilled items.



Ice Box - 70Ltr

Model No. : SIP-RIC-70LTR
Product Size(mm) : OD-L755 X W490 X H390
ID-L680 X W415 X 290

Ice Box - 25Ltr

Model No. : SIP-RIC-25LTR
Product Size(mm) : OD-L390 x W320 x H3300
ID-L340 x W270 x H275



NIRMALYA KUMBH KALASH

Nirmalay kalash is a "Divya Patra" which is using to store Nirmalayas at one point after Pooja at temples, River Ghat, Sea Bank, Residential and commercial complexes Etc. It is sign of Holiness of nirmalayas towards prayer of Human being to God and your dedicated efforts to maintain clean environment.



Nirmalya Daan Kalash With Plastic Stand



Nirmalya Daan Kalash With MS Stand



ROAD SAFETY PRODUCTS

ROAD SAFETY PRODUCTS



◀ **Traffic Cone, Round Base**
750MM & 1000MM

Traffic Cone, Hexagonal Base ▶
750MM & 1000MM



1 Mtr L Shape Road Safety Barricade



1 Mtr Nestable Road Safety Barricade
With Intermediator & Without Intermediator



ROAD SAFETY PRODUCTS

ROAD SAFETY PRODUCTS

1 Mtr Road Safety Barricade



1.5 Mtr Polo Road Safety Barricade



2 Mtr Road Safety Barricade



5 PCS MGL Safety Barricade



2.5 Mtr Expandable Barricade

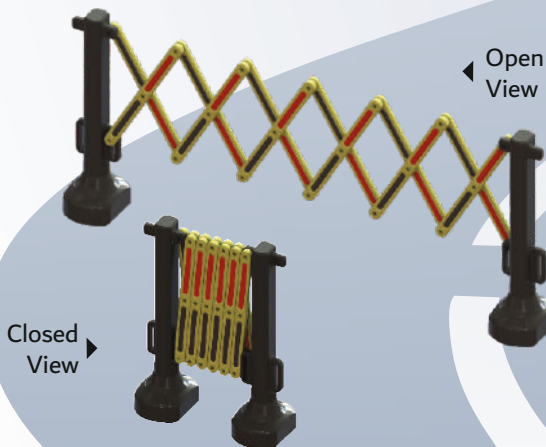

2 Mtr Fence Road Safety Barricade



FEW TERMS RELATED TO PLASTIC PALLETS

- **OneWay Cargo Export Pallets**

These type of plastic pallets are designed economically for one-way shipments or general light warehouse and storage use. They vary in design and weight.

- **Regular Application Pallets**

These types of pallets are used for storage and handling of goods internally in the industries, these pallets are made for repeated use application though they are strong and long life.

- **Stacking of Pallets**

These pallets are designed with a bottom deck that allows you to stack pallets on top of other loaded pallets without damaging the bottom pallet material it is traditional system of material storage in industries.

- **Nestable Pallets**

Swift offering nest able Plastic pallets reducing costs by saving warehouse and shipping space. Nestability allows for more pallets per truck and limits storage space needed in warehouse.

- **Static Load**

Total material weight kept on the pallet when it is in static position on ground.

- **Dynamic Load**

Total material Weight kept on the pallet when it is in lifting position at the time of movement of material from one place to another place.

- **Rack Load**

Total material Weight kept on the pallet when it is kept in the rack.

- **Pallet Dimensioning**

Dimension along with Fork length is considered as Length of pallet and Dimension perpendicular to fork is considered as Width (Fork Entry) of Pallets.



MATERIAL HANDLING EQUIPMENT



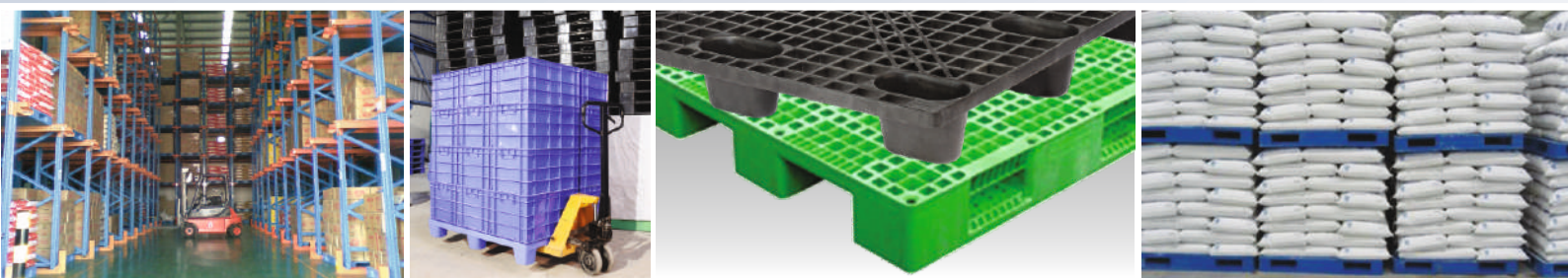

OUR PRODUCT RANGE



Plastic Pallets



Drum Spill Containment Pallets



Road Safety Products

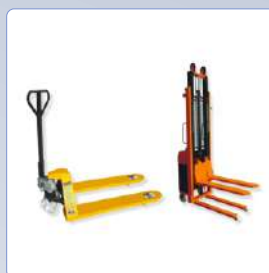

Material Handling Equipment



Insulated Ice Box

SWIFT TECHNOPLAST PVT LTD

B-116 - 117, TTC Industrial Area, Punit Industrial Estate, MIDC Turbhe, Navi Mumbai, Maharashtra, India - 400705

Tel: (+91) 8888 800 064 / 8888 870 873
 Email: marketing@swiftind.co.in
 Website: www.swiftind.co.in
 CIN: U25203MH2010PTC202558



This catalogue provides broad outline information of products. Due to continual improvement in the products, specifications information are subject to change without any notice. • Guidelines values are based on the experience and parts of standard testing procedure, Results may vary in different conditions of usage, accordingly these contains do not guarantee that application is possible as is to your company's usage condition. • It is always recommended to take trial as per your actual application in your premises before bulk purchase. • Colour options are available subject to minimum order quantity. Images shown in this catalogue are representative, actual product images and colours may vary.

